

OPERATOR'S MANUAL

EL - 405 EQUIPMENT LIFT

WARNING!
 Before operating this lift,
 read and understand this
 Operator's Manual.
 Become familiar with the
 potential hazards of this unit.
 Call SUMNER

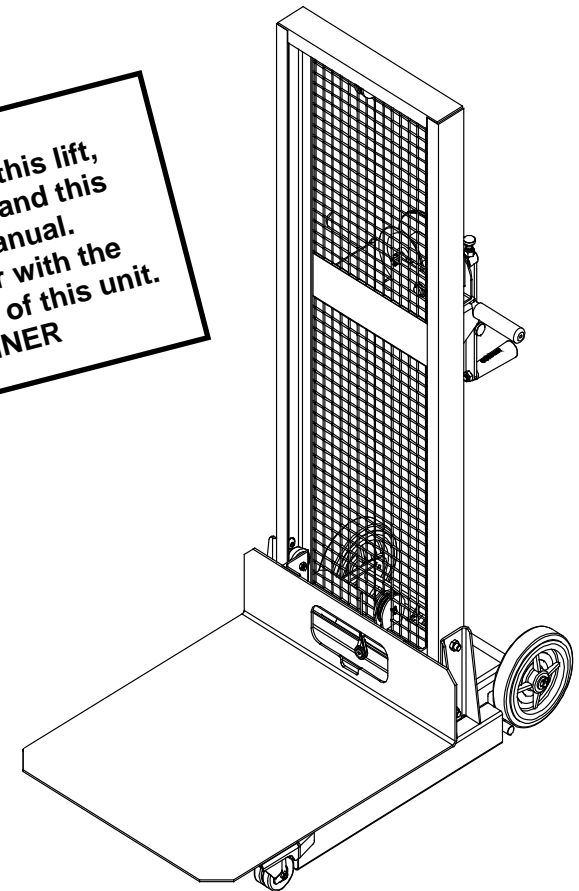

SUMNER®

US
 7514 Alabonson Road
 Houston, TX 77088
 phone: 281-999-6900
 fax: 281-999-6966

Canada
 1721 Bishop St. Unit #4
 Cambridge, ON N1T 1N5
 phone: 519-623-2300
 fax: 519-623-0744

UK
 Unit A6, Haybrook Industrial Estate
 Halesfield 9
 Telford, Shropshire TF7 4QW
 phone: 011-44-1952-586517

Index

Owner's Responsibilities2
 Operator Safety Instructions3-4
 Operating Procedure..... 5-11
 Assembling the unit.....5-7
 Moving Lift to Work Area 8
 Moving Lift with Load 8
 Lifting and Lowering Loads..... 9
 Foot Brake 9
 Winch Handle Positions..... 10
 Work Tray.....11
 Specifications..... 11
 Lift Diagram 12
 Load Capacity Chart 13
 Maintenance Instructions 14-15
 Troubleshooting 16
 Maintenance Record 17-18

OWNER'S RESPONSIBILITIES

Throughout this publication, the words WARNING, CAUTION and IMPORTANT will be used to alert the user to special instructions concerning a particular operation that may be hazardous if performed incorrectly or carelessly.

OBSERVE THEM CAREFULLY !!

WARNING



Hazards or unsafe practices which could result in severe personal injury or death.

CAUTION



Hazards or unsafe practices which could result in minor personal injury, product or property damage.

IMPORTANT



Indicates information or instructions that are necessary for proper operation and/or maintenance.

MAINTENANCE RECORD

Action	Date

OPERATOR SAFETY INSTRUCTIONS



IMPORTANT

Read and understand Operators Manual before using Lift.



Inspect cable before each use. Do not use if cable is frayed, worn, cut, burnt or otherwise damaged.

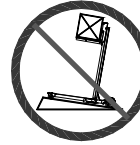

Use only on solid level surface. Keep work are clean and clear of clutter and debris.

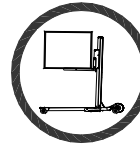

Test load balance before lifting. Do not use without properly installing legs. **Never exceed rated load capacity.**



Do not operate from an unstable platform, such as the bed of a truck.

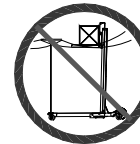

Stay clear of overhead wires and obstructions.

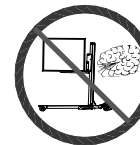

Never operate in gusty winds. Lifting loads during high winds can result in the lift tipping over and the possibility of operator injury.



Do not stand under an elevated load.



Never leave lift unattended with an elevated load.



Do not use to lift personnel. Do not sit or stand on lift.



Do not climb on mast or put a side load on mast. Do not use unit to support ladders for climbing or hoisting.



Do not use unit outside in thunder, lightning, or severe weather.



Wear proper clothing. Hard hat, safety shoes and gloves should be worn as a precaution when operating this lift.

Avoid horseplay around equipment, and keep bystanders at a safe distance. Do not allow children to operate this unit and always keep them out of work areas.

Do not misuse the lift. Perform only the functions for which the lift was designed.

Never use two lifts in tandem to lift a load that exceeds the capacity of a single lift.

Prior to each use of the unit, inspect all moving parts and the lifting cable to ensure they are in proper working condition.

MAINTENANCE RECORD

Lift Model Number _____

Lift Serial Number _____

Service Performed:

Action	Date
--------	------

Action	Date
--------	------

Action	Date
--------	------

Action	Date
--------	------

Action	Date
--------	------

Action	Date
--------	------

Action	Date
--------	------

Action	Date
--------	------

Action	Date
--------	------

Action	Date
--------	------

Action	Date
--------	------

Action	Date
--------	------

Action	Date
--------	------

TROUBLESHOOTING

PROBLEM	CAUSE	SOLUTION
Tray not rising	Overloading Check to make sure that the load does not exceed the 400 lb/140 kilo load limit.	Remove excess weight.
	Load may not be centered properly on the forks.	Check load capacity and reposition load.
	Slideways obstructed. Inspect tracks for debris, grease, or any foreign obstruction.	Clean mast section with a degreaser or brake cleaner and lubricate with a silicon lubricant.
	Inspect Lifting Cable for damage.	If Lifting Cable is cut, worn or frayed, replace the cable.
	Slideways are clean but mast still not sliding freely.	Inspect mast section for damage. Replace damaged mast.
Load is easing down slowly	The brake on the winch or ratchet dog are not installed correctly.	When load is in position, crank winch handles forward a half turn towards the lift to set the brake.
You have checked the winch and the brake does not work at all.	The brake ratchet or ratchet dog are not installed correctly or are damaged and/or worn.	Replace the winch.
The winch is hard to crank down.	The brake is over-engaged	Remove the load and turn the winch handle counter clockwise.
	The brake will not disengage	Replace the winch.
If none of these solutions seem to fix the problem...		Call distributor's Customer Service Department.

OPERATING PROCEDURE

1. Assembling EL-405
Your EL-405 lift will arrive in three sections, the base, mast, tray and hardware.



Step 1. To assemble your lift, first lay down all three pieces on the floor or table for easy viewing of the components. Lay the mast assembly on its back (winch side). Slide the tray into the mast from the bottom.

Step 2. Push the tray toward the top of mast as shown.

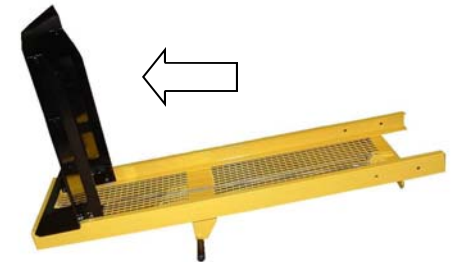

Step 3. Next, insert base into the mast as shown. Secure the tray to prevent it from sliding down during this operation.

Step 4. Secure base with the four 1/2 x 1 button head screws and 1/2 jam nuts. The screws must be inserted so that the head is on the inside of the mast and the locknut is on the outside.



3. Examine all bolts and nuts to be sure they are tight.
4. Legs, tray, mast and base should be dent free and damage free.
5. Check damage (indentations) which can restrict the rotation of the Lifting Cable.
6. Raise work tray to inspect for free, smooth sliding action. Make sure slideways are free of dust and oxidation and spray a light coat of silicone lubrication in slideways.
7. Make sure caster wheels and 8" transport wheels rotate freely and are undamaged.
8. Check to be sure that all mast covers are attached to the lift.

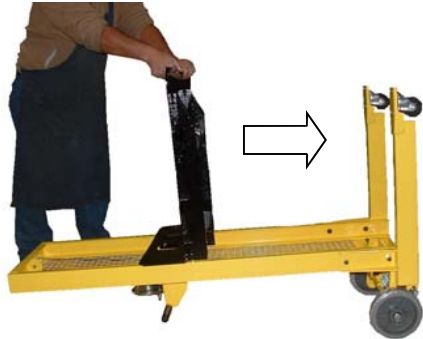

Step 5. Slide down the tray as shown.

WARNING



Replace all worn or damaged parts only with Sumner parts.

Step 6. Stand up the unit in operation position. Make sure the tray is all the way down to the legs before standing up the unit.



WARNING



Modifying the lift in any way can cause injury or death!

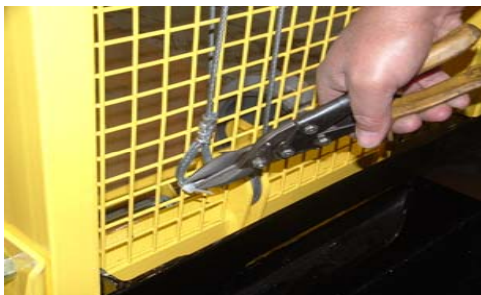

Step 7. Cut plastic tie holding lifting cable.

MAINTENANCE INSTRUCTIONS

Before each use:

1. Inspect the lifting cable for frays, cuts or burns. If any damage is visible on the lifting cable, do not use the lift.
2. Make certain winch operates freely and cable is not tangled on the winch drum.
3. Check tray, legs, mast, and base for bends.
4. Make sure caster wheels move freely.

Recommended Inspection Every 6 Months:

1. Inspect the lifting cable for frays, cuts or burns. If any damage is visible on the lifting cable, do not use the lift.
2. Make certain winch works freely and that there are no loose or damaged parts.

Winch Maintenance:

1. Be sure that winch covers are on the winch.
2. Check ratchet dog and brake ratchet for wear. If any wear is visible, replace the winch. If not, lubricate both parts with a light oil.
3. Inspect gear teeth for wear. If there is no sign of visible wear, brush teeth with 50-wt. Motor oil.

Replacing the Lifting Cable:

1. Lower the work tray.
2. Remove the large gear cover from the winch.
3. Remove cable from the winch by losing up the two bolts on drum.
4. Remove cable by unscrewing the screw in the tray.
8. Re-weave the new Lifting Cable through the lift .
9. Attach top end of cable on tray .
10. Attach new Lifting Cable to winch drum using the two bolts in step 3..

Note: The Lifting Cable must be fed from the bottom of the winch over the right side of the drum (looking from the back of the lift). Winding the Lifting Cable over the left side of the drum will prevent the brake from working.

11. Wind the slack cable tightly and evenly across the load drum.
12. Replace the winch covers.

General Maintenance:

1. Check the winch handle for wear or bends.
2. Inspect the lifting cable for frays, cuts or burns. If any damage is visible on the lifting cable, do not use the lift.

Step 8. Secure the lopped cable into the tray using washer rope retainer and 3/8-16 x 2 screw.

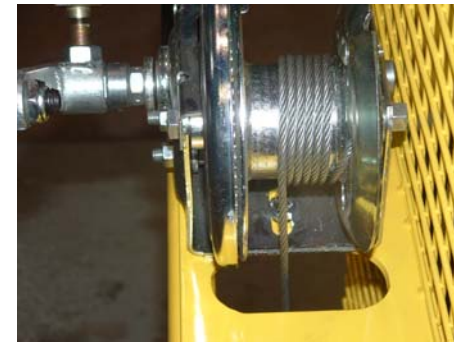
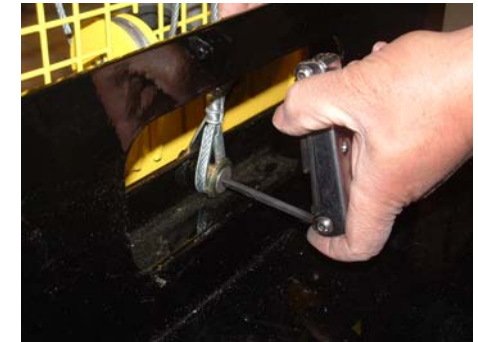

Step 9. Finally, wind the cable over the drum as shown.

WARNING



The cable must be wrapped in the proper direction for the brake to engage on the winch.

***Test the unit after assembly before lifting any load.**

2. Moving Lift to Work Area (No Load)

The lift is normally moved to the job site by rolling on its 3" casters and 8" wheels. **Note: Do not pull by the load lifting cable.**

3. Moving Lift in Work Area (With Load)

Always have the load in the lowest possible position before moving the unit. Make sure surface is smooth and level and that all four wheels contact the ground.



If it is necessary to move the unit with an elevated load:

- Make sure the area is clear of obstructions
- Keep personnel away from the load and behind the operator's position
- Move the unit slowly, avoiding sudden jerky starts and stops
- Make sure the load is secure and properly balanced. Note load capacity at given centers on page 14.

LOAD CAPACITY CHART

WARNING



The center of gravity of the load should never extend past 25" from the front of the lift.

WARNING



The center of gravity of the load should always be centered between the legs and as far back towards the lift as possible.

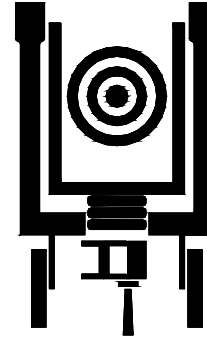

CAUTION



If a load is being transported, it should be secured to the tray to avoid shifting.

WARNING



No riders allowed on this unit. This is not a personnel lift and never should be used for hoisting or moving people.

CAUTION



Make sure the floor surface is level.

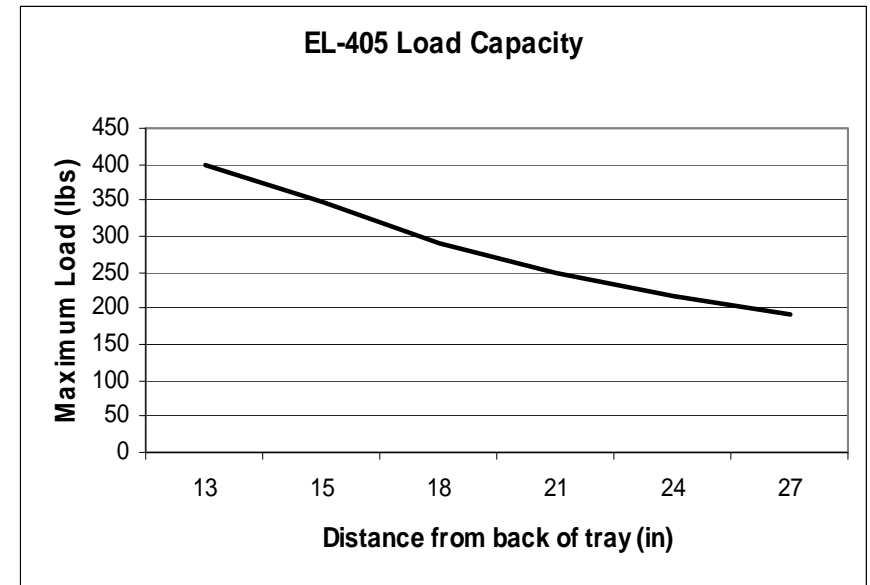

LIFT DIAGRAM

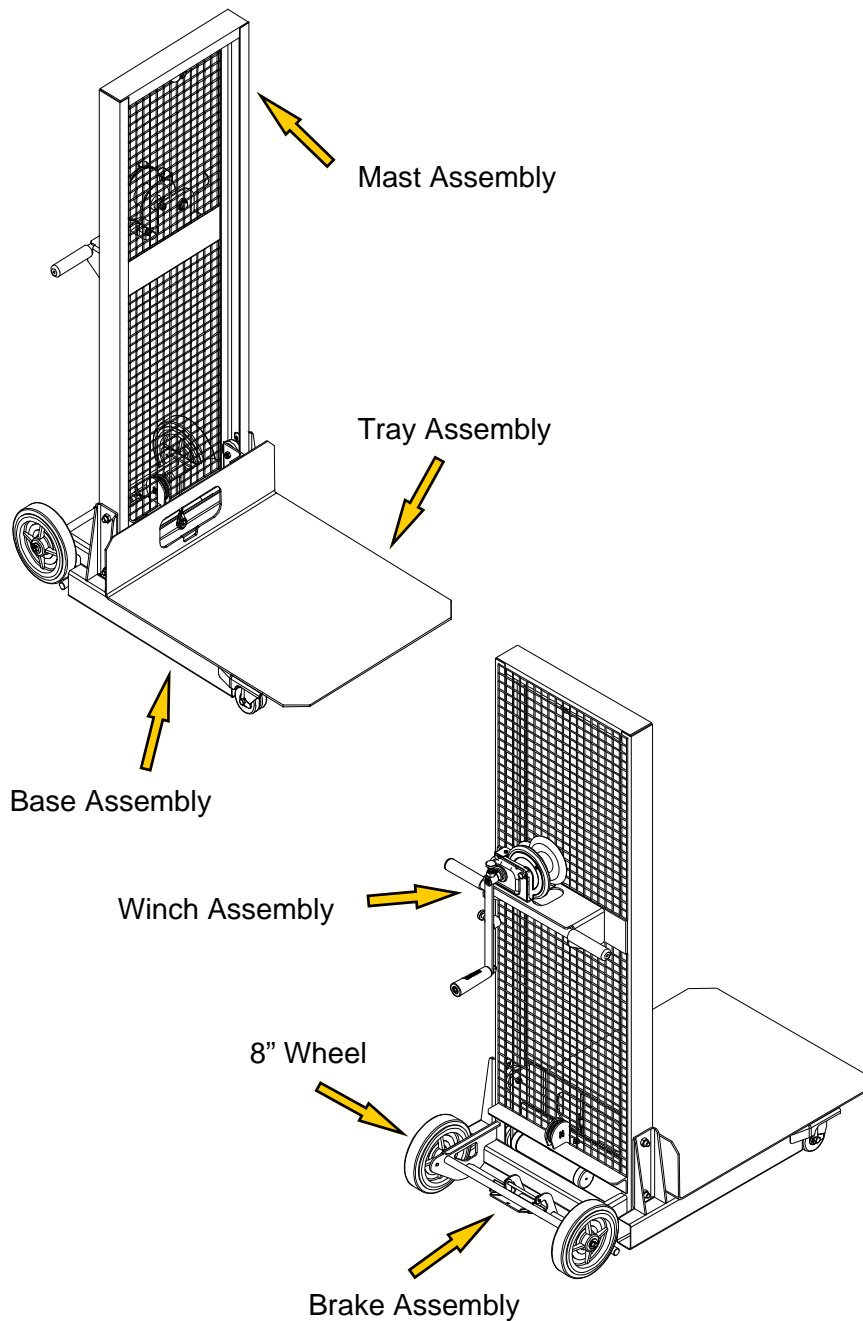

4. Lifting and Lowering Loads

Use the winch to crank forks up or down into the desired position.

Any unstable load must be *balanced* and *secured* to the tray prior to lifting.

Turn winch crank clockwise to elevate the load, while watching for overhead obstructions. Turn winch handle counter clockwise to lower the load.

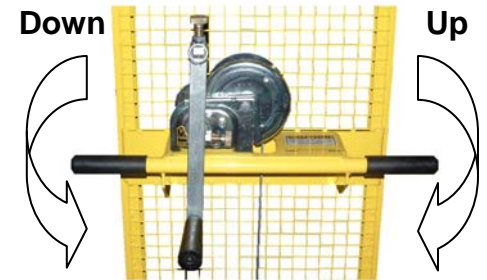

5. Foot Brake (784218)

To operate the brake, press the brake pad with your foot until the brake locks into place. When you hear the "snap" you know the brake is locked into place.

To release the brake, slide your foot underneath the brake pad and raise up until the brake unlocks. When you hear the "snap" you will know the brake is unlocked.



6. Winch Handle positions.

- Low Speed



- High Speed



- Storage



10

7. Retention Strap Operation

The quick action retention strap holds loads on the lift. The strap features a retractor to house the loose strap. The strap has a seat belt style push button release and a ratchet tightening mechanism.



SPECIFICATIONS

Dimensions

Height Operating
 Length Operating
 Base Width (Narrow)
 Base Width (Wide)
 Ground Clearance
 Load Height (minimum)
 Maximum Height

Tray Specifications

Tray Width
 Tray Length

Weight

Net Weight

Load Capacity

EL-405		
(in.)		(cm)
61		154.9
43		109.2
25		63.5
37.2		94.5
0.75		1.9
4.5		11.4
53		135
24	61	
28	71	
182 lb		82.5 kg
400 lb		180 kg

11